

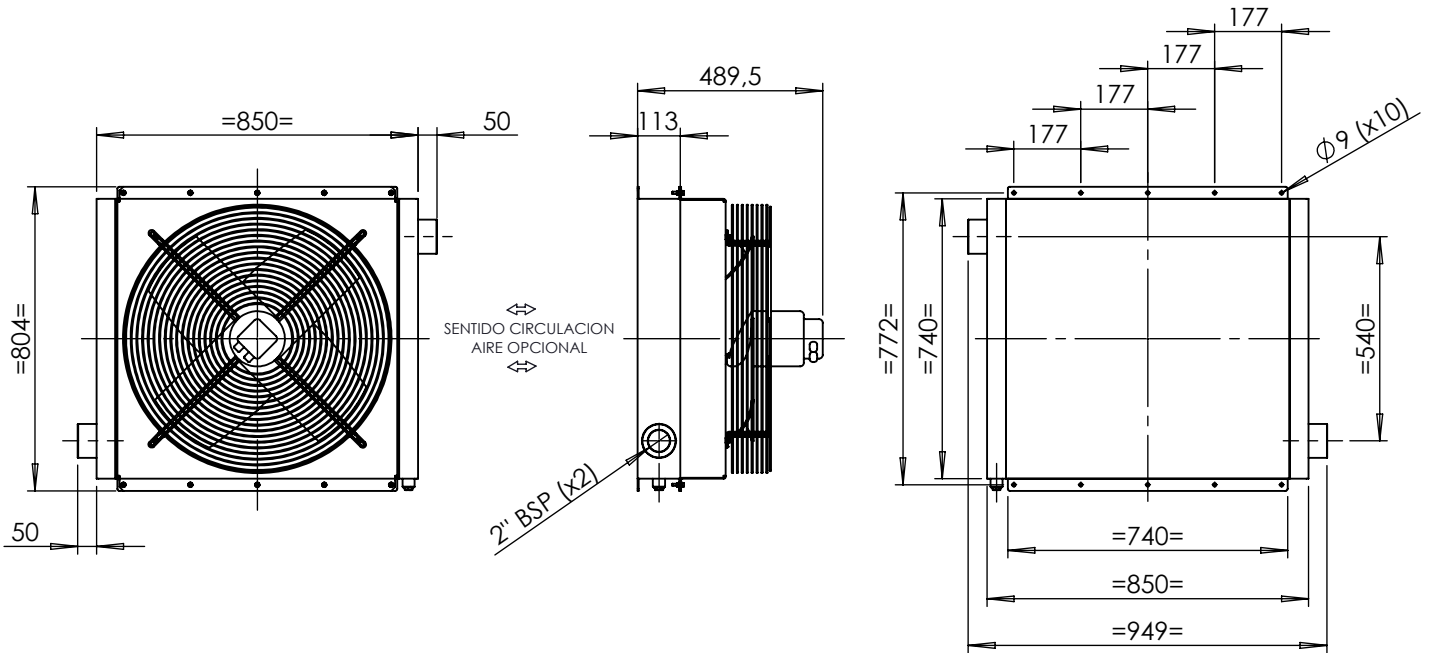

# Refrigerador de Aceite/Aire Air/Oil Heat Exchangers

# MBP-630

(Motor C. A. / A. C. Motor)



**380**  
Volt

TEST  
**20**  
bar

STATIC  
**15**  
bar

DYNAMIC  
**12**  
bar

## Datos Técnicos / Technical Information

Modelo Model	Caudal Oil flow (L/min)	Peso Weight (kg)	Voltaje Voltage (V)	Corriente Current (A)	Potencia Power (KW)	Caudal aire Air flow (m <sup>3</sup> /min)	Ø Ventilador Fan Ø (mm)
13120	70-240	78	380	1.48	0.55	182	630

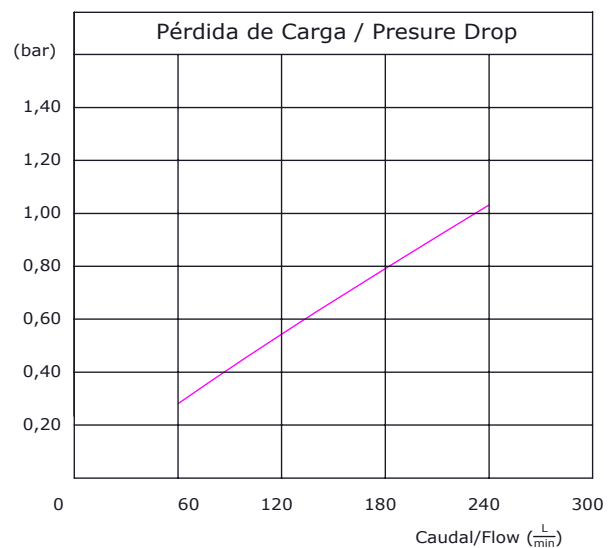
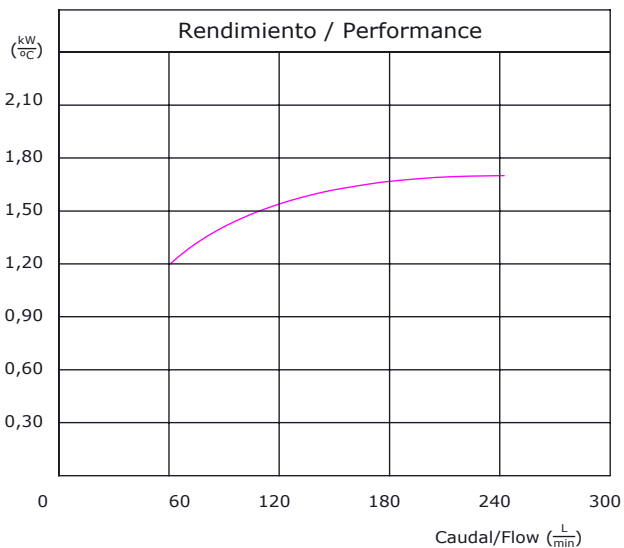

1 kW = 860 Kcal/h - 1 kW = 1,341 HP

Corrección de Viscosidad - Viscosity Correction  
 Aceite - Oil: ISO VG @ 40° C 22 32 46 68 150  
 Multiplicar por - Multiply for: 0,7 0,9 1 1,1 2